

FOREWORD

This booklet contains a complete review of the discussonal slidefilm, **Servicing the Corvair Powerglide Transmission**, (Part 1, Description and Operation). Keep at least one copy of this booklet in the Service Department file of Technical Information.

TABLE OF CONTENTS

	Page
DESCRIPTION OF MAJOR COMPONENTS	1
TRANSMISSION OPERATION ON-THE-ROAD	4
Manual Low	4
Drive	4
Drive to Low	5
Reverse	5
Downshifts { Coast	6
{ Part Throttle	6
{ Full Throttle	7
HYDRAULIC COMPONENTS	7
HYDRAULIC PRESSURES	8
Normal Mainline	8
Increased Mainline in "R"	10
Modulated (Low Vacuum) in "N" "D" "R"	11
Modulated (High Vacuum) in "N" "D" "R"	12
Increased Mainline in "L"	13
Governor	14
Throttle Valve	15
CONTROLLING THE SHIFTS	17
Drive	18
Downshifts { Full Throttle	20
{ Part Throttle	21
{ Coast	22
Manual Low	23
Drive to Low	24
Reverse	25
Neutral	25
NON-REGULATING HYDRAULIC COMPONENTS	26
Front Pump Air Bleed Ball Valve	26
Rear Pump Priming Ball	26
Front and Rear Pump Check Valves	27
Line Pressure Limiting Valve	27

The 1960 Corvair Powerglide is an entirely new 2-speed automatic transmission. Many of the design and operational features of the regular passenger car Powerglide and Turboglide transmission have been incorporated.

DESCRIPTION OF MAJOR COMPONENTS

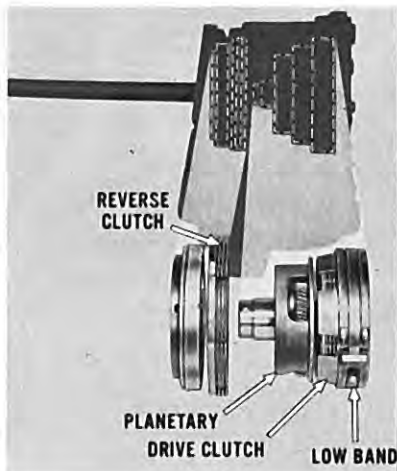
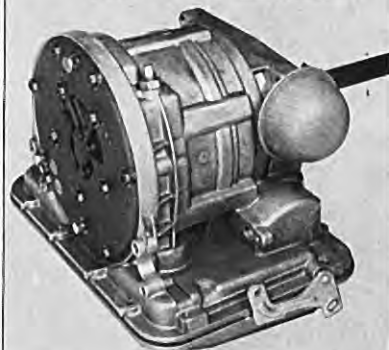

This planetary gear transmission, combined with torque converter drive, provides suitable and effective speed and power ratios from the engine to the rear wheels, using hydraulic pressure to apply the low band, drive clutch or reverse clutch.

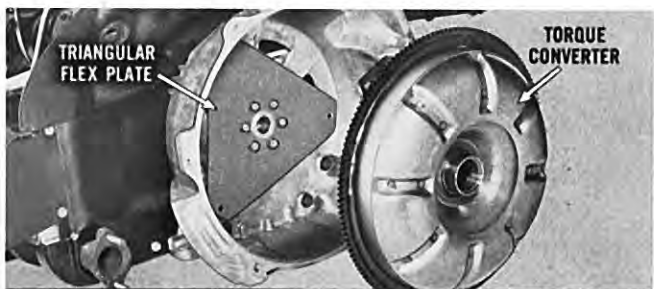

Inside the air-cooled torque converter is a pump mounted to the housing, a turbine which is fluid driven by the pump and a stator assembly mounted on a fixed support. These components are sealed within an all welded cover, which is driven by the engine crankshaft through a triangular flex plate.

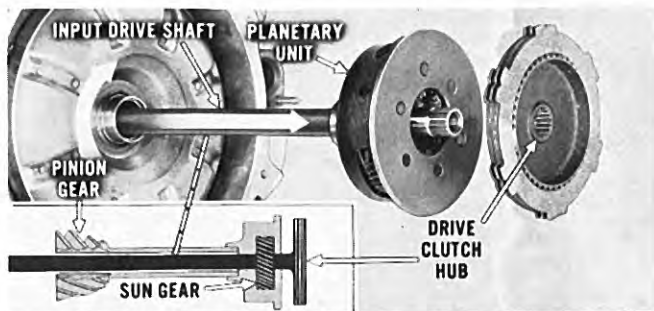

Power is delivered from the converter to the transmission by a hollow input drive shaft splined to the converter turbine. This shaft passes through the hollow rear axle pinion gear and is splined to the input sun gear of the planetary unit and to the drive clutch hub.

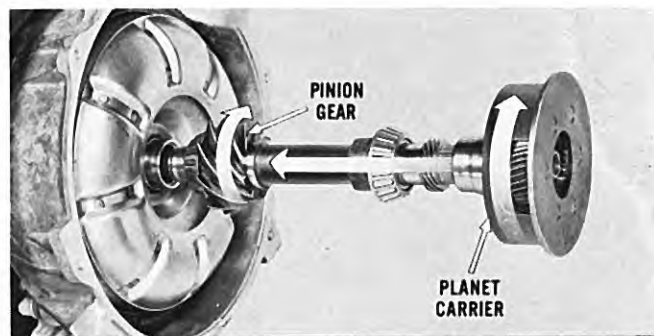

Power flow in the planetary gear train is the same as in the regular passenger car Powerglide. Power flow from the transmission to the rear axle is through the planet carrier which is splined to the hollow rear axle pinion gear shaft.

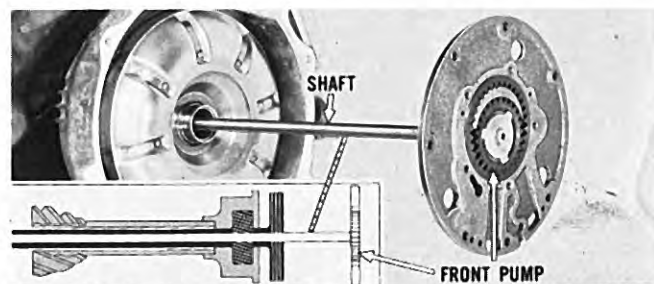

Hydraulic pressure, circulation and lubrication are developed through the use of two internal-external gear type oil pumps. The front pump is driven by a tubular shaft which extends through the input drive shaft and is splined to the converter pump hub. The front pump rotates whenever the engine is running.

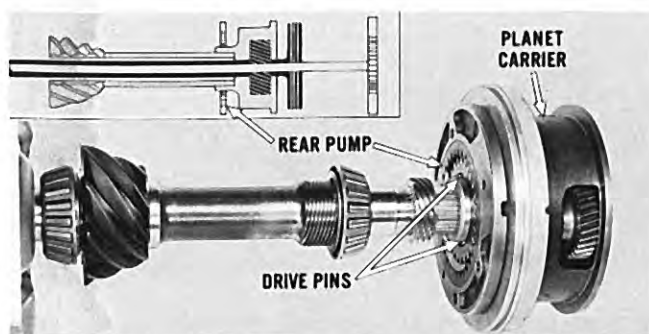

The rear pump is driven by two pins located on the output shaft hub of the planet carrier assembly and rotates whenever the rear wheels are turning. Push starts can be made at about 18 to 20 mph.

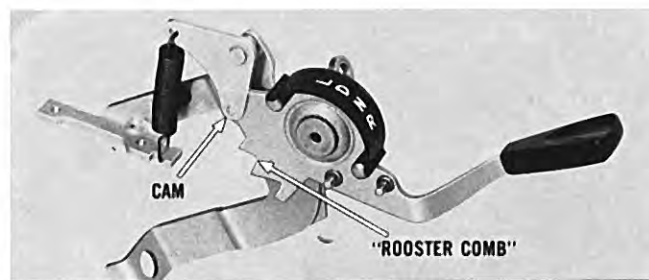

Control of the transmission is obtained by positioning a selector lever mounted on the instrument panel to any one of three selective drive ranges, Drive, Low or Reverse. Neutral range transmits no power to the rear wheels. Correct lever placement for each range is provided by a "rooster comb" and a spring loaded cam.

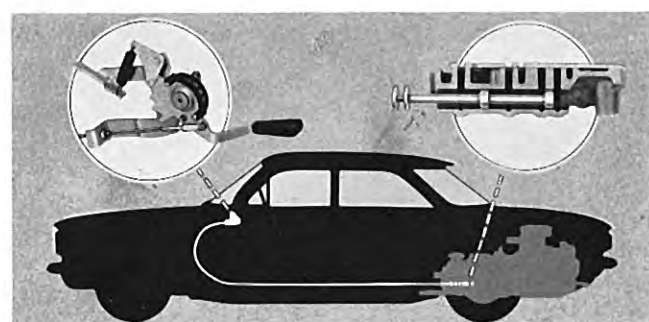

A non-adjustable flexible cable, running through a conduit underneath the car, connects the selector lever to the manual valve located in the transmission valve body.

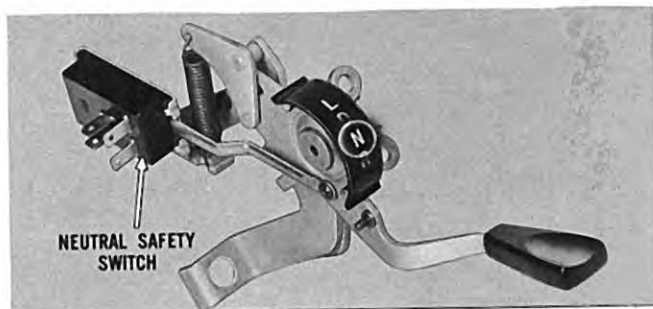

An electrical neutral safety switch, attached to the selector lever assembly, is wired to prevent the starter from cranking the engine in all ranges except neutral. Now let's "get behind the wheel" and see how the transmission operates in the various drive ranges.

TRANSMISSION OPERATION ON-THE-ROAD



MANUAL LOW: Moving the selector lever to "L" position causes hydraulic pressure to apply the brake band. The car starts forward in low range, geared 1.82 to 1. The transmission will not upshift regardless of accelerator pedal travel or engine load conditions.



DRIVE: This is the normal driving range. Moving the selector lever to "D" position causes hydraulic pressure to apply the brake band. The car starts forward in the same low gear reduction range as in "L" position, 1.82 to 1. However:

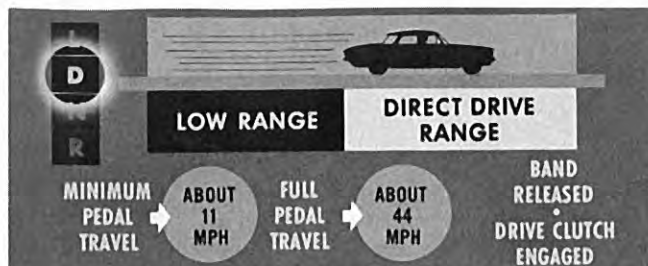

An automatic upshift into direct drive range occurs when vehicle speed and throttle conditions are proper for direct drive operation. At minimum pedal travel the shift occurs early (about 11 mph). Full pedal travel "delays" the upshift so that it occurs later (about 44 mph). When the upshift occurs, the brake band is released and the drive clutch is engaged. NOTE: Vehicle speeds plus or minus 3 mph.



DRIVE TO LOW: With the transmission in direct drive range and car speed above 45 mph, moving the selector lever from "D" into "L" does not cause a downshift. However, with the lever still in "L" and speed below 45 mph, a downshift will occur.



REVERSE: Moving the selector lever to "R" causes hydraulic pressure to engage the reverse clutch. The drive clutch and the low band are released. The car will move backward in the same gear reduction as low range, 1.82 to 1. The selector lever should never be moved between "R" and "D" while the vehicle is moving to prevent damaging the transmission or drive line components.

Automatic downshifts, controlled by accelerator pedal position, are also incorporated in the transmission.

**COAST DOWNSHIFT
PART THROTTLE DOWNSHIFT
FULL THROTTLE DOWNSHIFT**

Each of these downshifts provides for better engine response and acceleration when called for, giving the driver complete control of the car to meet engine load and road conditions.



FULL THROTTLE DOWNSHIFT: With the transmission upshifted into direct drive range and car speed below 41 mph, "flooring" the accelerator pedal (through detent) will cause a full throttle downshift into low range. "Detent" is the point reached in pedal travel where a definite resistance to further movement can be felt.



COAST DOWNSHIFT: With the transmission upshifted into direct drive range, releasing the accelerator pedal (closed throttle) will cause an automatic coast downshift into low range when car speed drops to about 11 mph.

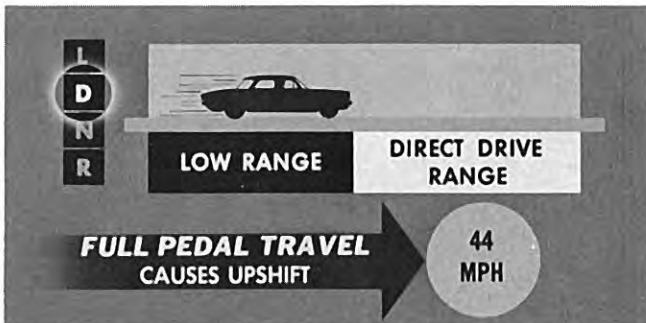

With the transmission in automatic low due to a full throttle downshift, maintaining full pedal travel will cause an automatic upshift when car speed reaches about 44 mph. This feature guards the engine from overspeeding.

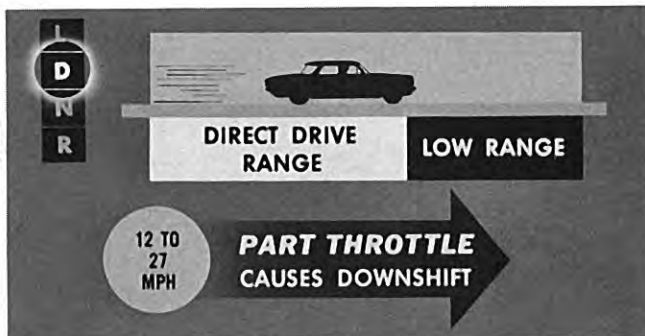

PART THROTTLE DOWNSHIFT: With the transmission upshifted into direct drive range and car speed between 12 and about 27 mph, pressing the accelerator pedal to part throttle position will cause a downshift.

HYDRAULIC COMPONENTS

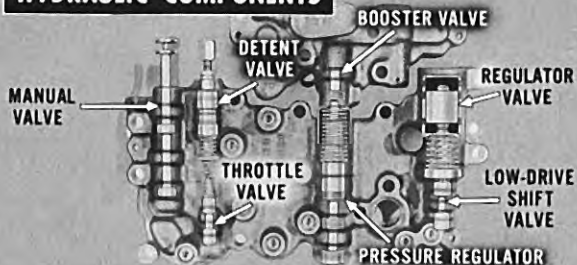

The components which make up the hydraulic system are located in two areas of the transmission. The main valve body assembly contains the Manual valve, Detent and Throttle valves, Booster valve, Pressure Regulator, and Regulator and Low-Drive Shift valves.

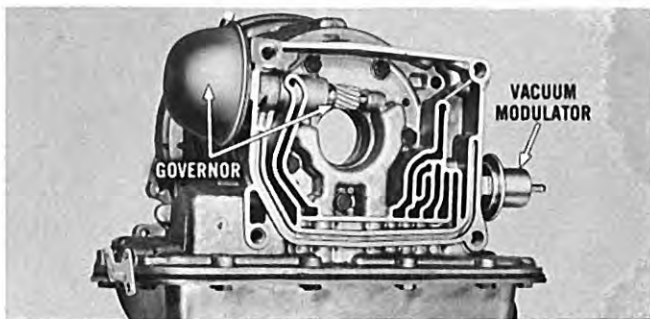

The units which are also part of the hydraulic oil circuit system are the Governor assembly and the Vacuum Modulator valve assembly. These two units are interconnected with the main valve body through oil passages in the aluminum case.

HYDRAULIC PRESSURES

The next section of this film is an explanation of how the hydraulic components regulate and develop the variable pressures. These pressures increase or decrease according to transmission requirements.

- MAINLINE PRESSURE is regulated pump output pressure controlled by the pressure regulator valve.
- GOVERNOR and THROTTLE VALVE (TV) PRESSURES are re-regulated mainline pressure, controlled by the "speed sensitive" governor and the "accelerator pedal sensitive" throttle valve.

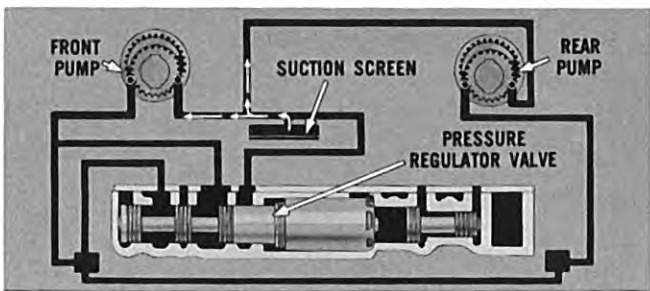

NORMAL MAINLINE PRESSURE: As the front and rear pumps rotate, they draw oil through a fine mesh suction screen and force it under pressure to the pressure regulator valve. This valve can be called an automatic, self-adjusting pressure relief valve which rapidly opens and closes an exhaust port to control and regulate pump output pressure.

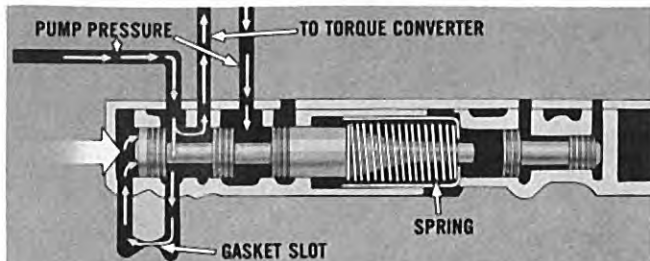

Pump pressure is directed to the left of the valve through a gasket slot, causing the valve to move against spring force. When pressure behind the end of the valve reaches about 60 psi, valve movement opens a separate passage leading to the torque converter. The converter is kept filled through this circuit whenever the front or rear pump is delivering pressure.

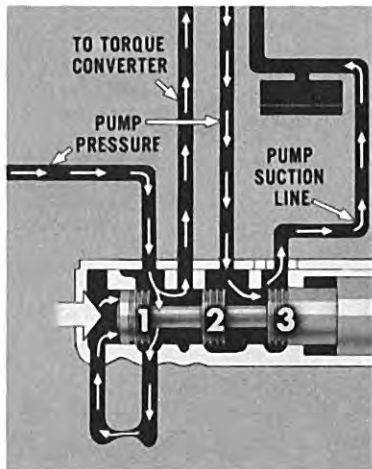

When the converter is filled with oil, pump pressure continues to move the valve against spring force until the area between the second and third spools is partially opened to exhaust (pump suction). Pump output pressure automatically decreases as oil by-passes through this passage.

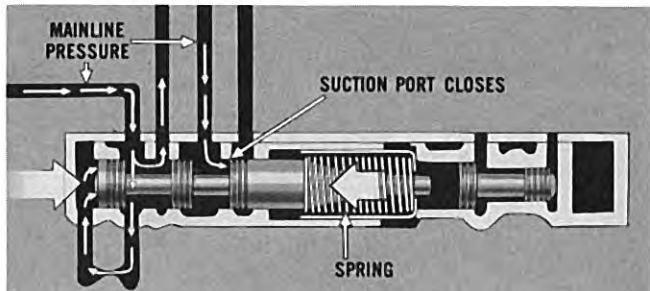

The instant pump output pressure drops, spring force causes the valve to close the suction port. The rapid closing and reopening of the suction port maintains pump output pressure at a constant hydraulic force which is called mainline pressure.

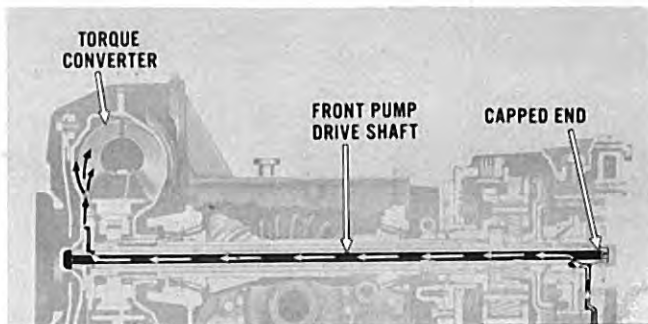

The torque converter receives oil pressure from the pressure regulator valve, through the hollow front pump drive shaft which is capped at the pump end. Oil enters the converter housing through a drilled hole in the shaft surface.

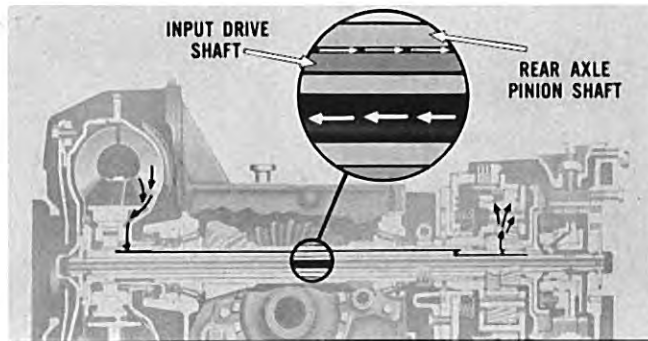

When the converter is filled, oil returns to the transmission through the area between the input drive shaft and rear axle pinion shaft to lubricate the bushings and planetary gearset.

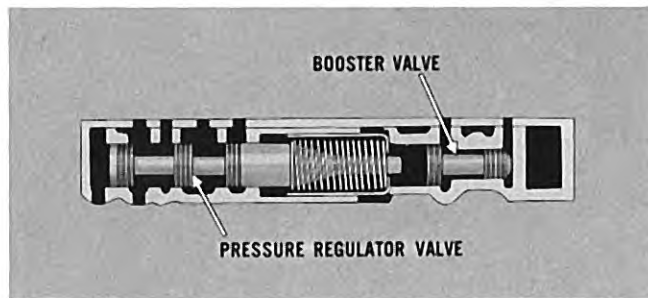

INCREASED MAINLINE PRESSURE IN "R": Under certain engine load and operating conditions an increase in mainline pressure is necessary. A booster valve is used to "boost" mainline pressure. In reverse, this is accomplished as follows:

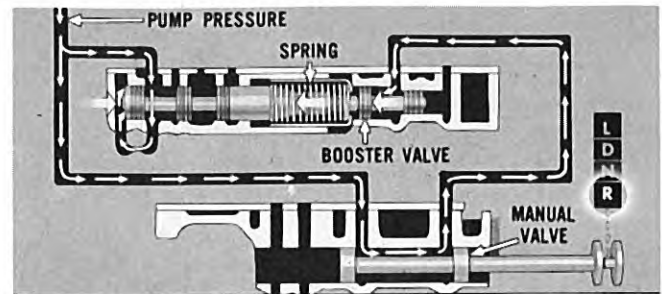

An opened passage in the manual valve body releases mainline pressure to the large spool of the booster valve. This hydraulic force applied to the booster valve assists the spring. Therefore, pump pressure, acting on the pressure regulator valve, will be regulated at a higher pressure.

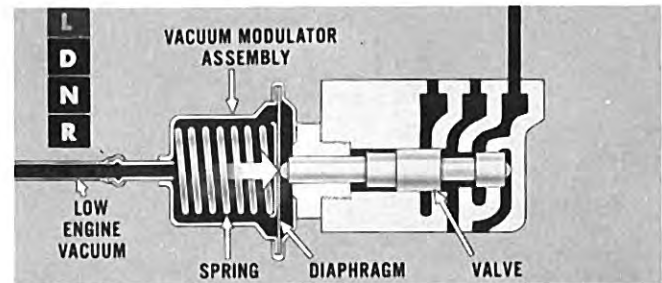

MODULATED PRESSURE (LOW VACUUM): In "N," "D" and "R" ranges, mainline pressure is also increased utilizing engine vacuum and a vacuum modulator assembly. With the engine under load conditions (low vacuum), the modulator spring forces the modulator diaphragm and valve to the right.

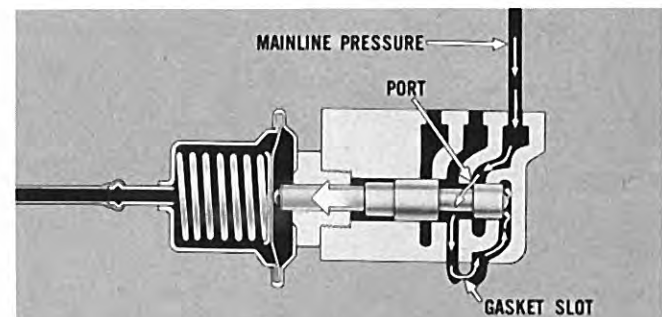

Mainline pressure enters through an area between the lands and is directed through a gasket slot to the right of the valve. The valve moves to the left and closes the mainline port.

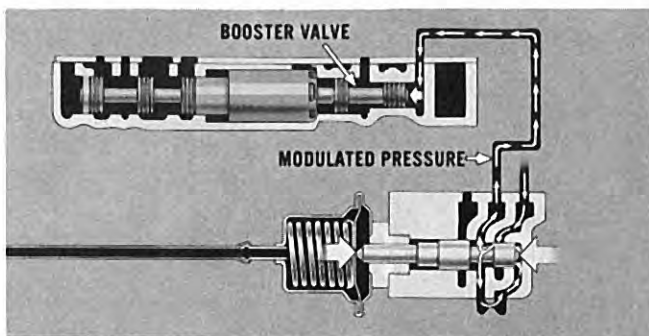

The valve balances at a point that is controlled by engine vacuum plus spring and mainline pressure forces. The pressure thus produced is called "modulated pressure" and is sent to the booster valve to "boost" mainline pressure.

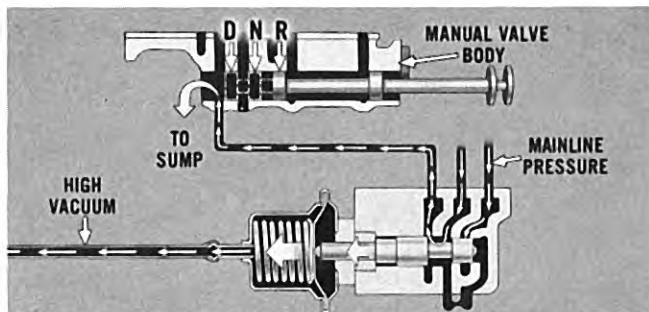

When engine vacuum increases, calling for a decrease in modulated pressure, mainline pressure force is now able to move the valve, opening a port leading to the manual valve body. Pressure in the modulator oil circuit then exhausts back to sump.

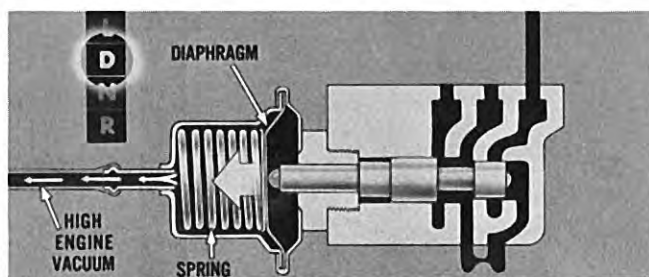

MODULATED PRESSURE (HIGH VACUUM): When operating in drive range under light load conditions (high engine vacuum) no increase in mainline pressure is required for proper transmission operation. When this occurs, vacuum applied to the modulator diaphragm compresses the spring and reduces spring force against the valve.

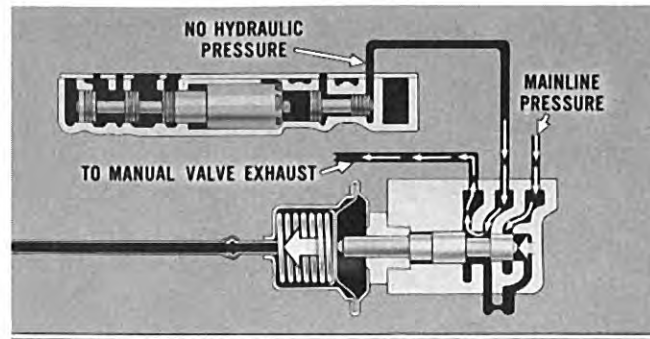

Hydraulic pressure within the modulator oil circuit now exhausts through the manual valve exhaust passage. Therefore, the pressure regulator valve maintains only normal mainline pressure.

As we have seen, mainline pressure increases when manifold vacuum is low. This increase in transmission operating pressure is required to hold the band or clutch with greater hydraulic force and prevents the possibility of slippage.

However, mainline pressure returns to normal when manifold vacuum is high. This pressure supplies sufficient and correct hydraulic force to prevent harsh or rough application of the band or clutch during upshifts or downshifts.

ENGINE LOAD	MANIFOLD VACUUM	MAINLINE PRESSURE
HEAVY	LOW	INCREASES
LIGHT	HIGH	NORMAL

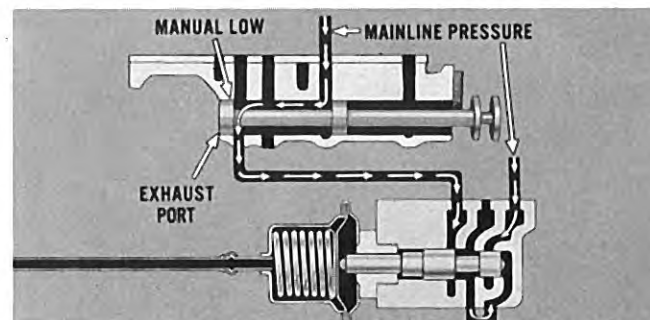

INCREASED MAINLINE IN "L": In manual low, mainline pressure is also increased. With the exhaust port closed by the position of the manual valve, the exhaust passage is now used to direct mainline pressure to the modulator valve.

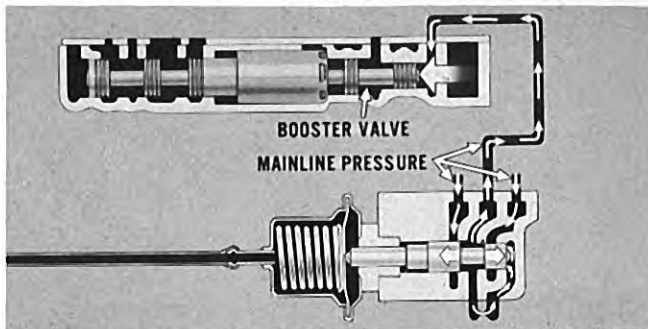

With the modulator valve balanced between mainline pressures, full mainline pressure is directed to the booster valve. The result is "peak" booster valve force which produces a maximum increase in mainline pressure.

In addition to mainline pressure which operates the transmission, two additional hydraulic forces—both variable—are required to control the transmission. They are:

GOVERNOR PRESSURE and THROTTLE VALVE (TV) PRESSURE

The components which produce these pressures operate as follows:

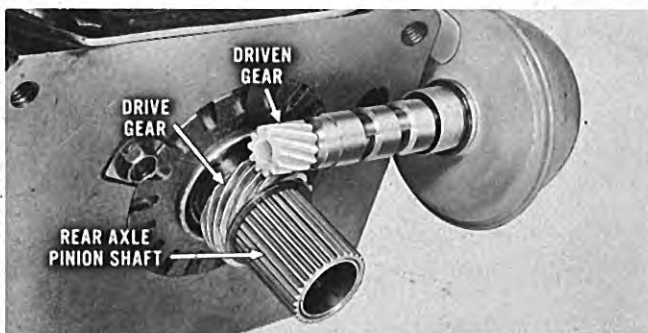

GOVERNOR: The governor can be called a "rotating pressure regulator." It is driven by a gear on the rear axle pinion shaft and receives part of the rear pump output pressure through a passage in the case.

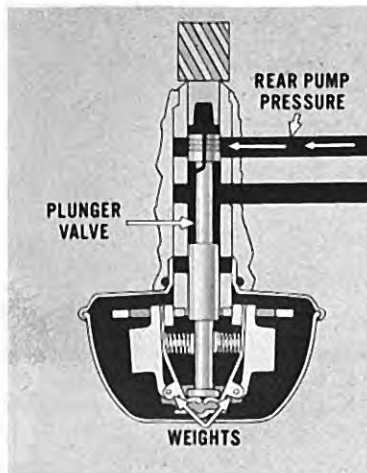

Two sets of revolving weights control movement of a plunger type valve in accordance with car speed. At very low rpm, the weights do not rotate fast enough to actuate the valve, keeping the rear pump pressure port closed.

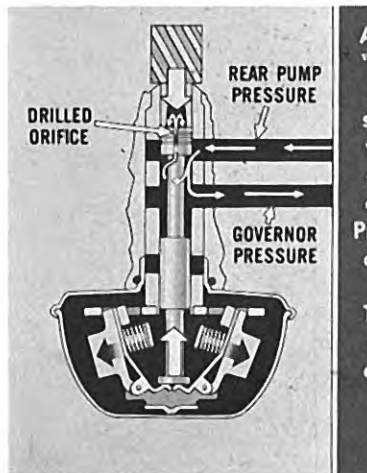

As the weights gradually "throw outward" due to centrifugal force, pressure is admitted into the valve area and through a drilled orifice into the cavity at the valve end. Pressure against the valve opposes the centrifugal force of the weights. Therefore, the governor regulates this pressure and releases it as governor pressure which varies in proportion to car speed.

If only governor pressure was used to control the shifts, the transmission will always upshift and downshift at the same car speed regardless of accelerator pedal travel. To provide greater transmission flexibility a

THROTTLE VALVE

is employed. It operates to produce a variable "TV" pressure which opposes the variable governor pressure.

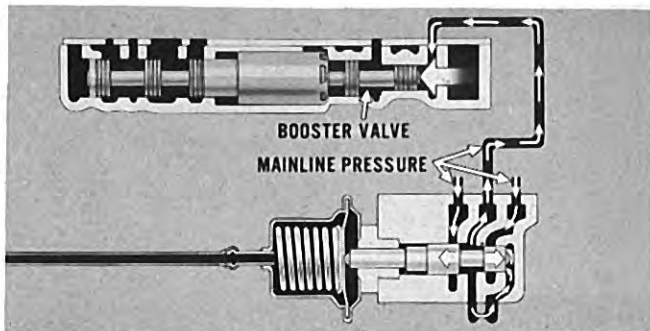

With the modulator valve balanced between mainline pressures, full mainline pressure is directed to the booster valve. The result is "peak" booster valve force which produces a maximum increase in mainline pressure.

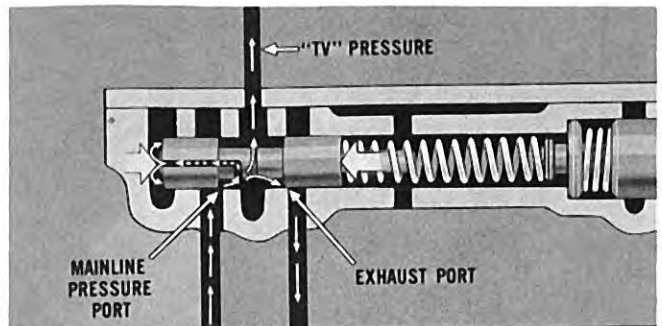

Hydraulic and spring forces then equalize throttle valve movement and the valve balances at a point between the exhaust port and the mainline pressure port. "TV" pressure is released in proportion to opposing spring force.

In addition to mainline pressure which operates the transmission, two additional hydraulic forces—both variable—are required to control the transmission. They are:

GOVERNOR PRESSURE and THROTTLE VALVE (TV) PRESSURE

The components which produce these pressures operate as follows:

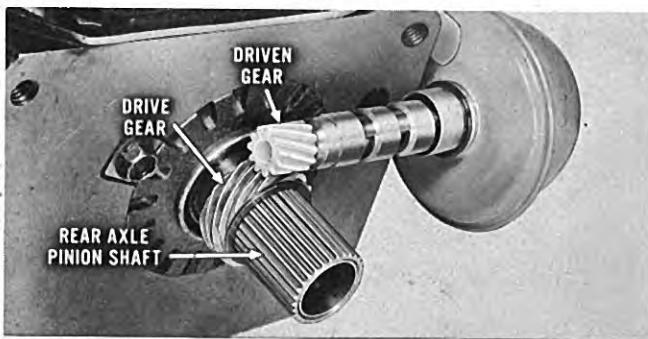

GOVERNOR: The governor can be called a "rotating pressure regulator." It is driven by a gear on the rear axle pinion shaft and receives part of the rear pump output pressure through a passage in the case.

In reviewing how "TV" pressure is developed by re-regulating mainline pressure, it is important to remember that two forces control this pressure.

- Throttle valve spring force increases through movement of the accelerator pedal which is connected by linkage to the throttle valve plunger.
- However, as we have seen earlier, part of the mainline pressure force is constantly working against the valve end and opposes any spring force.

These opposing forces vary according to accelerator pedal position. Therefore, "TV" pressure is a variable hydraulic force controlled by the driver for automatic shifting.

CONTROLLING THE SHIFTS

We now have an understanding of governor and throttle valve operation. The next section of this film is an explanation of how hydraulic pressures sent to the

- **LOW-DRIVE SHIFT VALVE**
- **REGULATOR VALVE** and
- **DETENT VALVE**

control upshifts and downshifts.

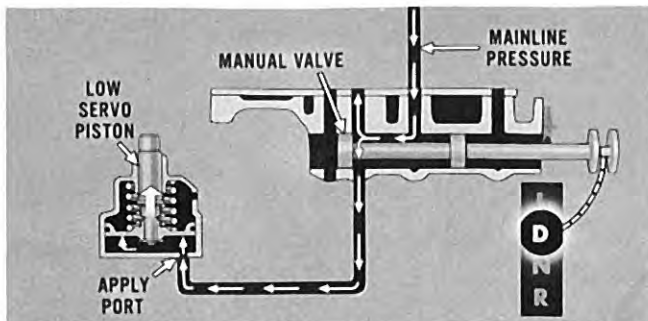

DRIVE: Mainline pressure is directed from the manual valve to the apply port of the Low Servo Piston, causing the piston to apply the low brake band. The transmission is then in "reduction" and the car will start forward in low range.

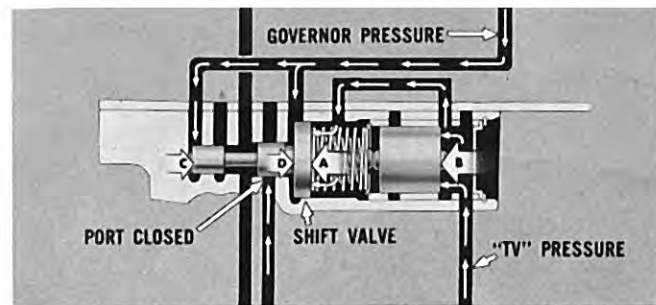

The transmission will remain in automatic low (mainline port closed) whenever the forces due to "TV" pressure applied directly to area "B" and "A," plus spring force, have an advantage over the force due to governor pressure acting on the shift valve at area "C" and "D."

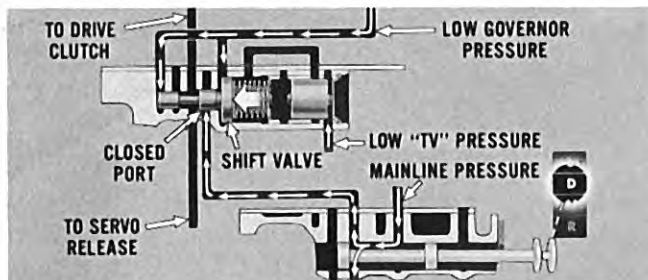

Mainline pressure is also directed from the manual valve into a separate passage leading to the low-drive shift valve. With low governor pressure and "TV" pressure, the shift valve spring force keeps the mainline port closed and prevents pressure from entering the drive clutch and servo release passages.

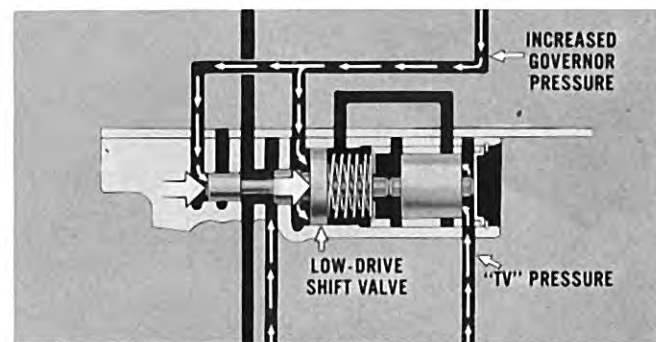

As governor pressure increases, a hydraulic pressure point is reached which overcomes the opposing "TV" and spring forces. Any slight advantage in governor pressure snaps the shift valve (and regulator valve) to the right.

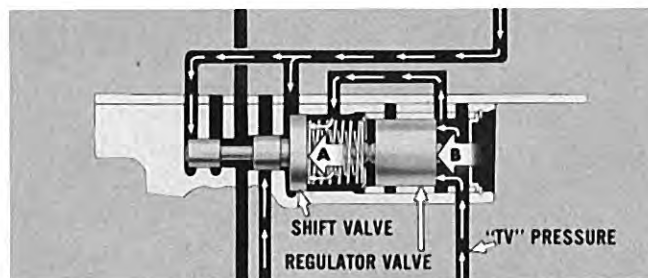

As "TV" pressure develops, this hydraulic force is applied directly to area "B" of the regulator valve and moves the regulator valve to the left against the stem of the low-drive shift valve. At the same time, the "U" shaped passage port opens and permits "TV" pressure force to apply directly to area "A" of the low-drive shift valve.

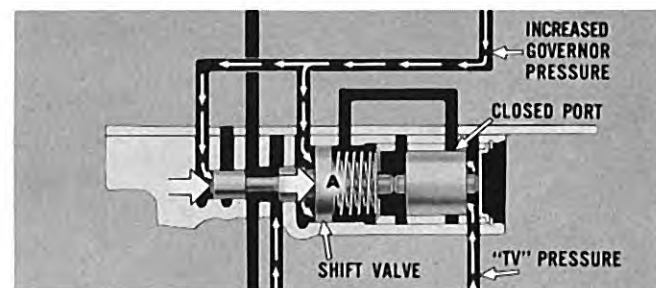

When the regulator valve moves to the right, it closes the "U" shaped passage port and stops "TV" pressure from acting on area "A" of the shift valve. This sudden decrease in hydraulic force at "A" permits governor pressure to snap the shift valve to the right and prevents "hunting" or sluggish valve movement.

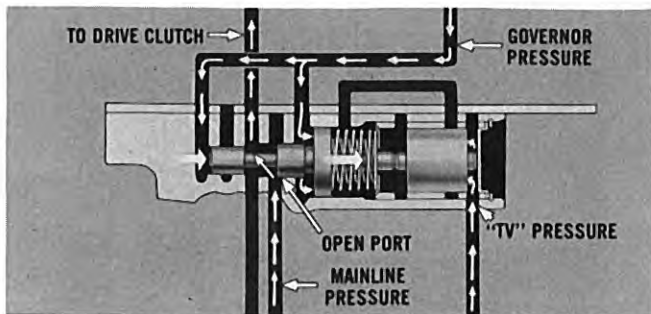

The moment the shift valve snaps to the right mainline pressure enters through the open port and is directed to the drive clutch, engaging the drive clutch plates. At the same instant to provide split-second timing of the shift, mainline pressure is applied to . . .

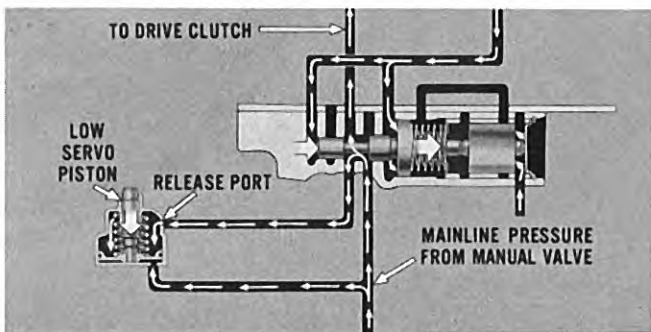

. . . the release side of the low servo piston. The piston, balanced against equal mainline pressure directed from the manual valve, is released due to servo spring force. The transmission is then upshifted into direct drive range.

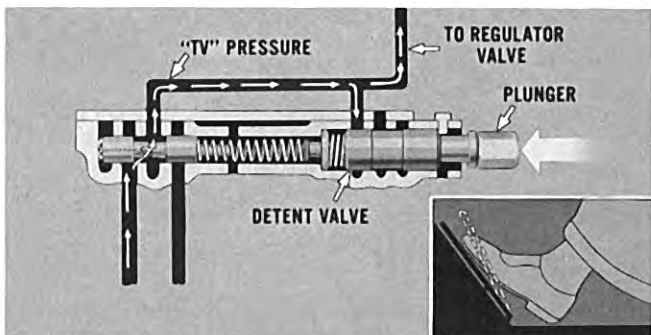

FULL THROTTLE DOWNSHIFTS: "TV" pressure is always present at the detent valve. Travel of the accelerator pedal (through detent) moves the plunger which moves the detent valve.

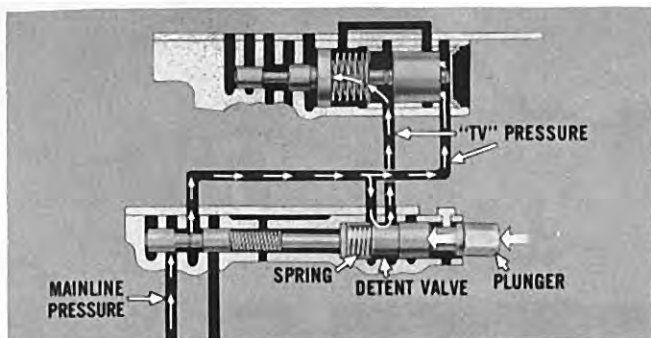

When maximum travel of the accelerator pedal is reached, the detent valve is forced forward against detent spring resistance and opens a separate passage to the low-drive shift valve.

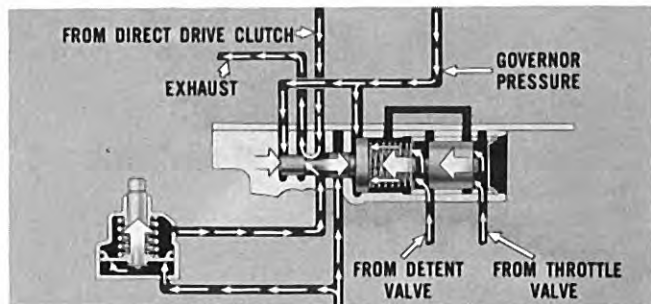

Maximum "TV" pressure, released from the detent valve and throttle valve, is imposed directly on the large diameter of the shift valve. These hydraulic forces, plus spring force, overcome governor pressure, and the transmission downshifts to low range (between 25 to 44 mph).

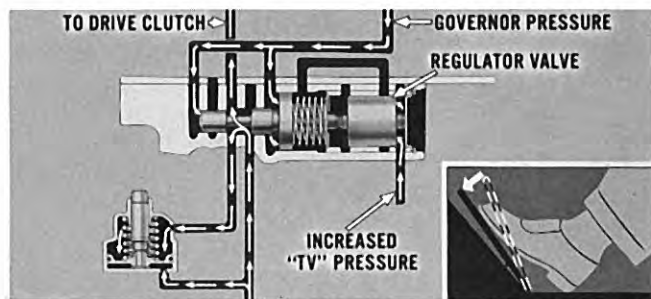

PART THROTTLE DOWNSHIFTS: A part throttle downshift can be made when car speed is under 27 mph and "TV" pressure plus spring force are sufficient to overcome governor pressure. To accomplish this, "TV" pressure (increased due to part throttle operation) is applied directly to the large area of the regulator valve.

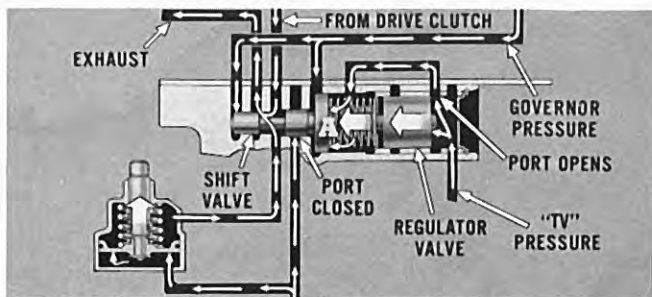

As the regulator valve and shift valve begin to move to the left, they uncover the "U" shaped passage port. This permits "TV" pressure to also apply against area "A" of the shift valve, snapping the valve to the left. With the mainline entry port closed the drive clutch releases, the band applies, and the transmission is in low range.

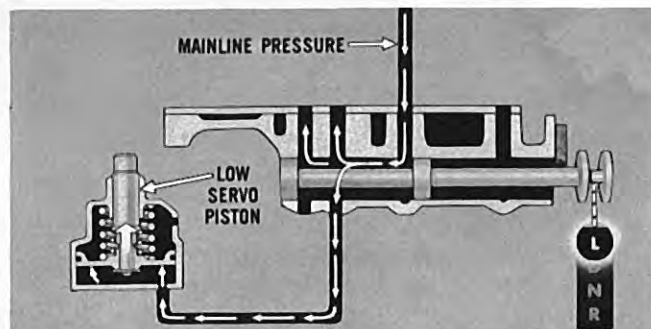

MANUAL LOW: Mainline pressure is sent directly to the low servo piston, applying the low brake band. The car starts forward in low and will not upshift due to the following oil pressures:

The operation of the regulator valve and the low-drive shift valve is similar to the conventional Powerglide. However, only the Corvair Powerglide provides a part throttle downshift.

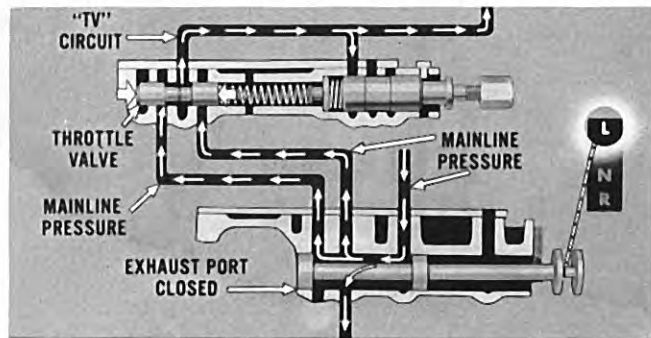

When the manual valve is positioned in "L" range, the exhaust port is closed. Mainline pressure is then directed to two ports in the throttle valve body and the throttle valve releases full mainline pressure into the "TV" circuit.

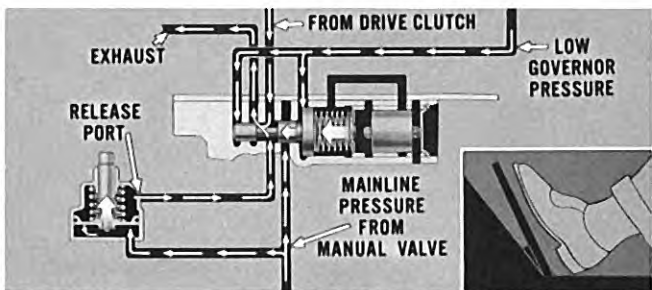

COAST DOWNSHIFTS: At about 11 mph, decreasing governor pressure permits shift valve spring force to move the shift valve to the left. This returns the shift valve to the low range position. The exhaust passage is opened and permits clutch apply and servo release pressures to exhaust to sump.

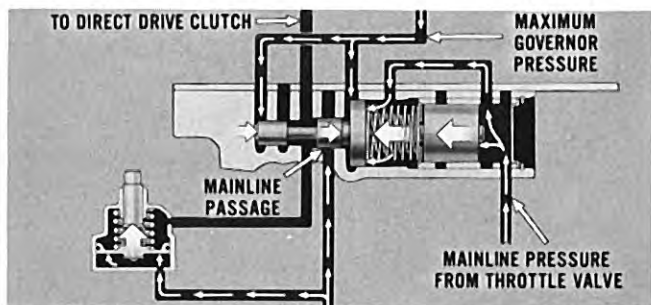

This full mainline pressure force in the "TV" circuit applied to the regulator valve and to the shift valve, plus spring force, is sufficient to oppose maximum governor pressure and keeps the shift valve from opening the mainline passage to the drive clutch and servo. Therefore, an upshift will not occur.

DRIVE TO LOW: When in direct drive range, it may be desirable to place the transmission in manual low because of road or operating conditions.

However, moving selector lever from "D" to "L," at speeds above approximately 44 mph, will not cause transmission to downshift because of a protective inhibiting feature which controls hydraulic operation as follows:

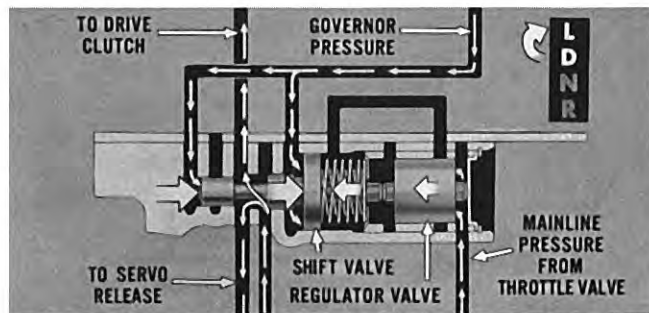

Mainline pressure directed from the throttle valve to the regulator valve, plus spring force, is not sufficient to overcome governor pressure. Therefore, the shift valve remains in high range position until car speed drops and governor pressure is reduced. At speeds below 44 mph—

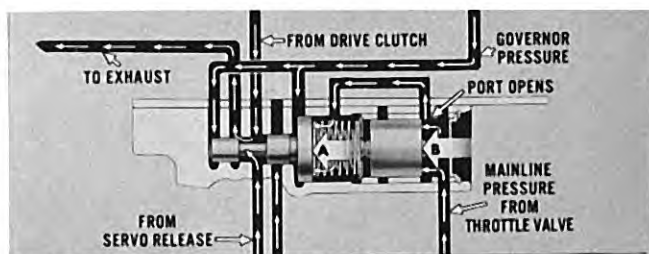

—governor pressure is reduced to the point where mainline pressure, plus spring force, can now overcome it and cause regulator and shift valves to move to the left. The shift valve is now in low range position. With the "U" shaped passage port opened, mainline pressure force now acting on two pressure sensitive areas "A" and "B," plus spring force, keeps the shift valve in low range position regardless of car speed or governor pressure.

PRESSURE REGULATION "D" TO "L": With the selector lever in "D" range and the carburetor in a closed throttle position (car in operation), manifold vacuum is high and mainline pressure is at a minimum.

Therefore, when shifting from "D" to "L," additional holding force is required to prevent band slippage on transmission downshifts into "L" range.

As we have seen earlier, when the manual valve is positioned in "L" range, mainline pressure applied to the booster valve causes the pressure regulator valve to provide a maximum increase in mainline pressure for maximum hydraulic force to the servo and band.

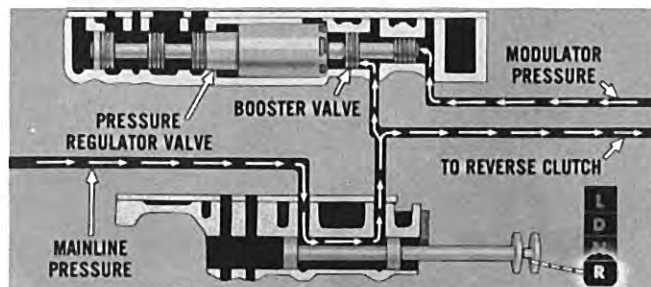

REVERSE: Mainline pressure is directed from the manual valve to the reverse apply passage and engages the multiple disc clutch. As we have seen earlier, mainline plus modulator pressures acting on the booster valve cause the pressure regulator valve to regulate at maximum mainline pressure.

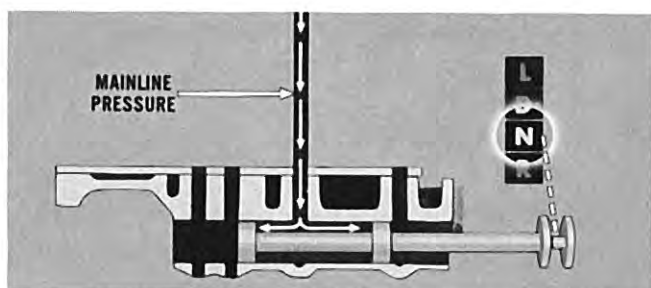

NEUTRAL: Mainline pressure directed to the manual valve is prevented from being released to any other component of the transmission. However, both the torque converter and the lubrication system receive mainline pressure through a separate circuit opened by the pressure regulator valve.

NON-REGULATING HYDRAULIC COMPONENTS

In addition to the major valve components incorporated in the hydraulic circuits, the following units are also required. They are the

- FRONT PUMP AIR BLEED BALL
- REAR PUMP PRIMING BALL
- FRONT and REAR PUMP CHECK VALVES
- LINE PRESSURE LIMITING VALVE

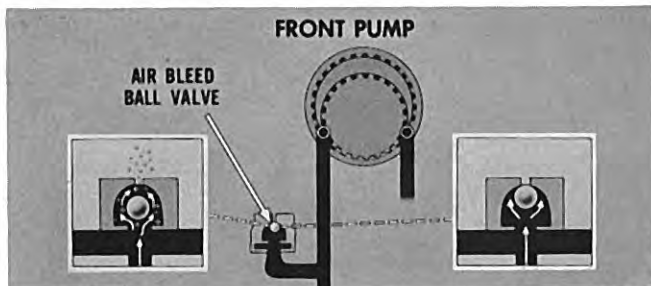

A front pump air bleed ball valve, loosely retained in the transmission case by a wire cage, permits any air that may be trapped in the pump circuit to escape when the engine is started. When all trapped air is discharged, oil pressure forces the ball to remain seated against the orifice port.

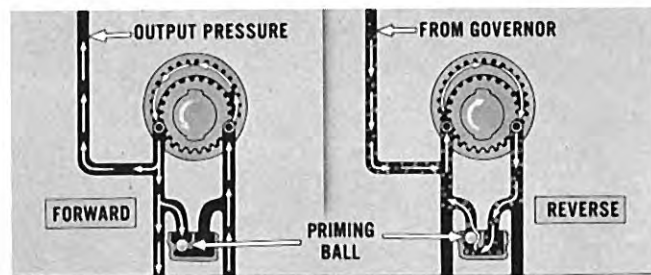

The rear pump priming ball, located in the valve body, seats with rear pump output pressure. However, when the rear pump turns backward in reverse, it tends to pick up air at the governor and discharge it along with fluid to front pump suction. This would cause erratic pressures. To prevent this, the reversed oil flow unseats the ball and causes oil to recirculate.

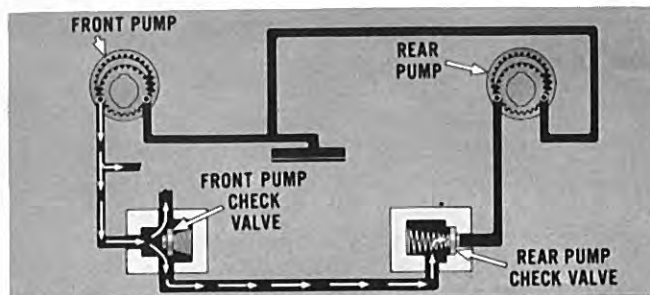

The front and rear pump check valves are located in the main valve body. The rear pump check valve closes when the front pump is providing most of the hydraulic pressures, such as at low car speeds or in reverse. This prevents front pump pressure from bleeding off through the rear pump.

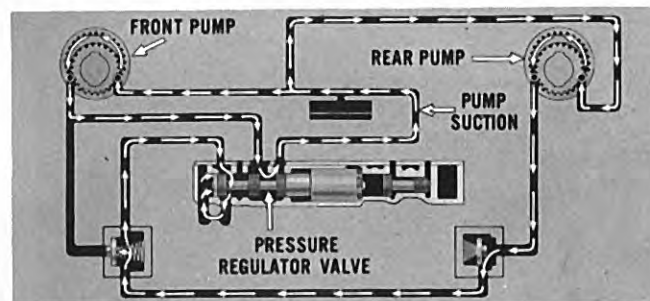

When the rear pump is producing sufficient volume to fully operate the transmission, the rear pump check valve opens and the front pump check valve closes. Front pump pressure then by-passes through the pressure regulator valve direct to pump suction, and drops to between 0 and 5 psi.

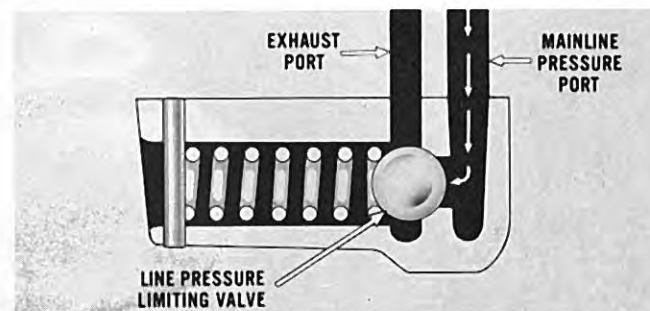

A line pressure limiting valve, located in the valve body, acts as a safety device to prevent any excessive and unusual hydraulic pressure from damaging the transmission. The ball unseats and bleeds oil back to the sump if line pressure exceeds 160 psi.

NOTES